

THERMAL TRANSFER SYSTEMS, INC.

Providing standard and custom designed industrial heat exchangers and exhaust silencing equipment since 1978

- Shell & Tube
- Plate Exchangers
- Spiral Exchangers
- Air-Cooled
- Heat Recovery
- Blower & Vent Exchangers
- Platefin Coils
- Electric Heaters
- Exhaust & Blower Silencers

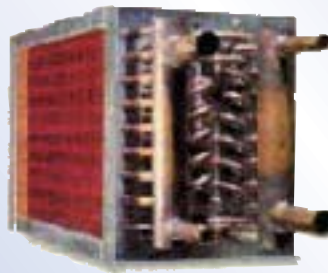
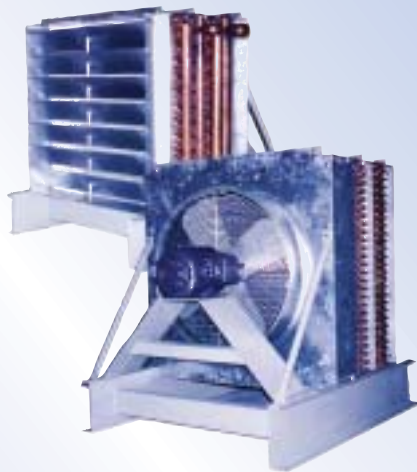

Shell & Tube Products



One Pass

Two Pass

Four Pass



Liquid Refrigerant Receivers
Suction Accumulators
Coalescing Oil Separators
Direct Expansion Water Chillers
Shell and Tube Condensers
Marine Condensers
LSX Exchangers



Aftercoolers



Plate Exchangers

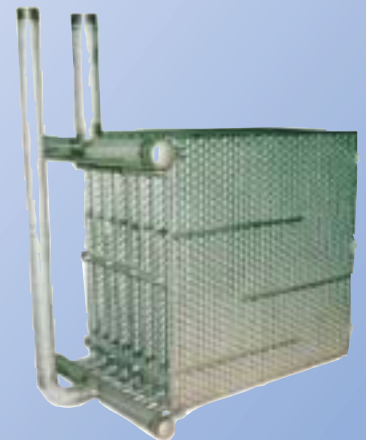

Shell & Tube • Plate Exchangers • Spiral Exchangers • Air-Cooled • Heat Recovery
Blower & Vent Exchangers • Platefin Coils • Electric Heaters • Exhaust & Blower Silencers

Air-Cooled Products

EXACT EXCHANGER INCORPORATED

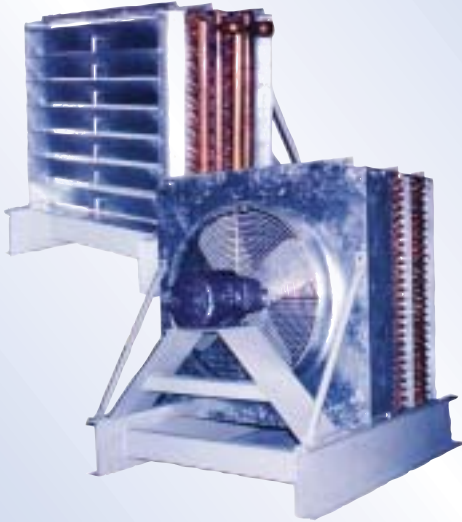

FINX



ROCORE
INDUSTRIES, INC.



**CLOSED CIRCUIT
COOLING SYSTEMS**

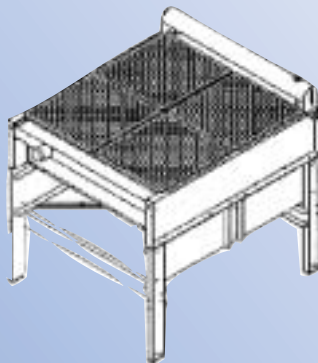
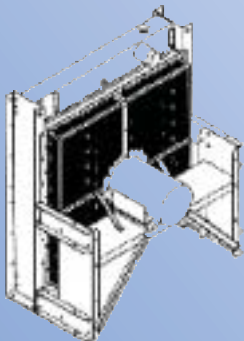

sales@thermaltransfersystems.com • www.thermaltransfersystems.com

800-527-0131 • 972-242-9600 • Fax 972-242-7568 • PO Box 795096 • Dallas, TX 75379-5096

Heat Recovery Products

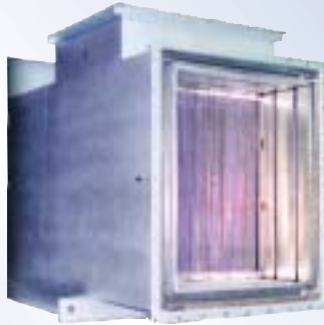
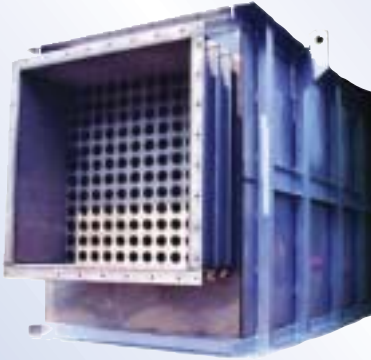

Electric Heaters

GAUMER
PROCESS HEATERS



ZEROSTART
COLD WEATHER STARTING PRODUCTS



Types of Electric Heaters

Flanged Immersion Heaters	Heating Cables
Flanged Circulation Heaters	Process Heaters
Screw-Plug Immersion Heaters	Process Air High Heaters
Screw-Plug Immersion Heaters with Integral Thermostat	High Temperature Wire and Accessories
Screw-Plug Circulation Heaters	Control Panels
Over-The-Side Immersion Heaters	Thermocouples
Strip Heaters	Air Heating Systems
Tubular Heaters	Packaged Fluid Heating Systems
Cartridge Heaters	Ovens
Mica Band Heaters	Comfort Unit Heaters
Hi-Temp Band Heaters	Silicone Rubber Heaters
Cast In Heaters	Thermostats
Drum Heaters	Heating Systems

Shell & Tube • Plate Exchangers • Spiral Exchangers • Air-Cooled • Heat Recovery
Blower & Vent Exchangers • Platefin Coils • Electric Heaters • Exhaust & Blower Silencers

Blower Exchangers & Tank Vent Condensers

Xchanger, Inc.

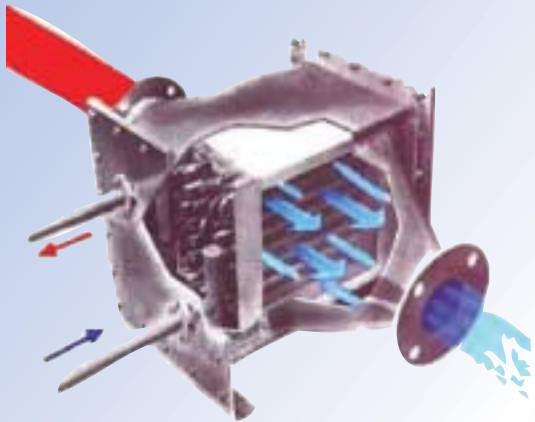
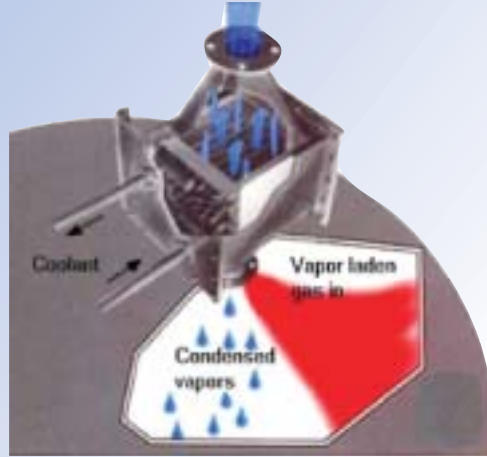

Platefin Coils

SUPER RADIATOR COILS



sales@thermaltransfersystems.com • www.thermaltransfersystems.com
800-527-0131 • 972-242-9600 • Fax 972-242-7568 • PO Box 795096 • Dallas, TX 75379-5096

Spiral Exchangers

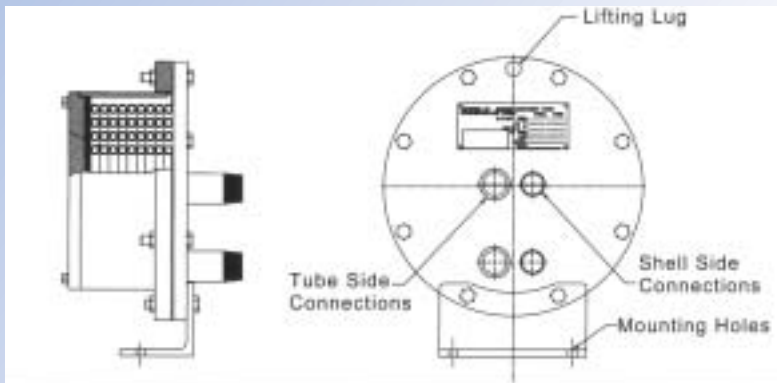

Exhaust & Blower Silencers



Shell & Tube • Plate Exchangers • Spiral Exchangers • Air-Cooled • Heat Recovery
Blower & Vent Exchangers • Platefin Coils • Electric Heaters • Exhaust & Blower Silencers

Premium Service, Realistic Deliveries & Fair Pricing

Thermal Transfer Systems, Inc. offers one of the most complete product offerings available for Industrial Heat Exchangers and Exhaust Silencers. Our goal is to provide our customers with sound engineering selections, realistic deliveries and fair pricing. Our local and factory inventoried items are available for same day shipment via UPS, motor freight or next day air carrier. Many items which are made to order are also available on a quick ship basis.

Our client base of OEM/reseller, industrial users and engineering firms range from the fortune 500 to the individual sole proprietorship. If you are a current client, we "Thank You" for your past and continued support. For those who are seeking a dependable supplier with our capabilities, we encourage you to contact us.

Listed here are some of the reputable firms we work with to bring you the premium service you have grown to expect from us throughout the years.

<p>ACME Air-Cooled Water Chillers (5-140) Tons</p> <p>AKG Thermal Systems, Inc. Aluminum Air Cooled Exchangers</p> <p>Alfa Laval Thermal Inc. Plate & Frame Heat Exchangers Weld Plate & Frame Heat Exchangers Plate Coils Spiral Exchangers</p> <p>Thermal Transfer Products Shell & Tube Exchangers (Stock & custom designs) Air-Cooled Exchangers (stock & custom designs)</p> <p>AMCOT Fiberglass Cooling Towers</p> <p>Aurora Industrial Machining Inc. (AIM) TEMA Shell & Tube Exchangers ASME Separators & Filters</p> <p>Chil-Con Products Ltd. Chillers • Condensers Receiver • Accumulators Separators</p> <p>Exact Exchanger Incorporated Air-Cooled Exchangers</p>	<p>Fin-X Inc. Vertical & Horizontal Air-Cooled Exchangers ASME Finned Tube Exchangers Replacement Sections</p> <p>Gaumer Company, Inc. Electric Process Heaters & Controls Packaged Systems</p> <p>Heat Transfer Systems, Inc. TEMA Shell & Tube Heat Exchangers Waste Heat Recovery Units</p> <p>IPAC 2000 Compressor Aftercoolers Moisture Separators Packaged Closed Loop Cooling Systems</p> <p>Kam Thermal Equipment, Ltd. TEMA Shell & Tube Exchangers U-Tube Bundle Assemblies Tank Heaters</p> <p>Phillips & Temro Industries Cowl Engine Exhaust Silencers EM Exhaust Silencers Blower Discharge Silencers Electric Heating Products ZeroStart</p> <p>Rocore Industries Radiator Cores Unit Mount Radiators Remote Mount radiators</p>	<p>R P Adams Company, Inc. Water-Cooled Aftercoolers Moisture Separators</p> <p>Sendure Products Inc. Marine Exchangers Engine & Transmission Coolers</p> <p>Sentry Equipment Corporation Spiral Exchangers Blowdown Exchangers Sample Coolers</p> <p>Super Radiator Coils Steam Coils Water Coils Evaporator Coils Condenser Coils Various materials of construction Replacements</p> <p>Temptek Inc. Air & Water-Cooled Portable Chillers (1/4-40 Tons) Oil/Water Temperature Controllers Cooling Towers</p> <p>Xchanger Inc. Air-Cooled Blower Heat Exchangers Water-Cooled Blower Heat Exchangers Tank Vent Condensers</p>
--	--	--

Heat Exchanger Inquiry Form

Provide the information below for a fast and accurate response

Company _____
 Address _____
 City, State, Zip _____
 Phone _____ Fax _____
 Contact _____
 Email _____

- AIR COOLED EXCHANGER**
 SHELL AND TUBE EXCHANGER
 PLATE AND FRAME EXCHANGER

	HOT CIRCUIT	COLD CIRCUIT
Fluid Circulated		
Liquid - GPM or #/hr		
Gas - CFM@ ___ PSIA & ___ °F ___ % R.H.		
Steam - #/hr		
Specific Gravity (Liquid)		
Molecular Wgt. (Gas)		
Viscosity @ ___ °F (SSU or CP)		
Specific Heat - BTU/#		
Operating Pressure (PSIG or PSIA)		
Temperature In - °F		
Temperature Out - °F		
Pressure Drop Allowed - PSI		
Fouling Factor		
Heat Transferred - BTU/hr		
Materials Of Construction Required		
ASME Stamp Required Yes / No		
TEMA Requirements Yes / No (Shell and Tube only)		
Electric Requirements (Air Cooled only)		
Mounting Configuration Vertical / Horizontal		
Space Limitations		

**THERMAL TRANSFER
 SYSTEMS, INC.**
 PO Box 795096 • Dallas, TX 75379-5096

PRSR STD
U.S. POSTAGE
PAID
DALLAS, TEXAS
PERMIT NO. 7

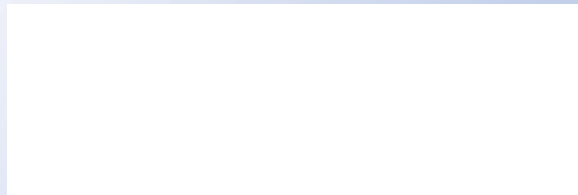

Shell & Tube • Plate Exchangers • Spiral Exchangers • Air-Cooled • Heat Recovery
 Blower & Vent Exchangers • Platefin Coils • Electric Heaters • Exhaust & Blower Silencers

sales@thermaltransfersystems.com • www.thermaltransfersystems.com • 800-527-0131 • 972-242-9600 • Fax 972-242-7568